



San Diego, CA 92110 USA
www.ecr4kids.com

Adjustable Art Easel Model# ELR-008-A



WARNING:

Adult Assembly Required.

- Two adults recommended.
- Contains small parts, sharp points and edges.
- Do not stand, sit, kneel, climb, lean or pull on unit for support.
- Never leave children unattended.
- Do not place unit near high heat or moisture.
- Adult supervision recommended.

TOOLS INCLUDED

- Hex Tool (1)



Parts List

BEFORE ASSEMBLING, MAKE SURE YOU HAVE ALL THE PARTS

A Chalk Board (1)

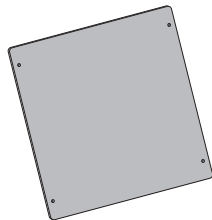

B Dry Erase Board (1)

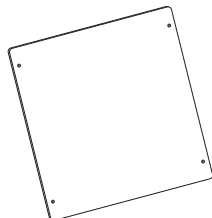

Batch ID Sticker located on backside

C Trays (2)

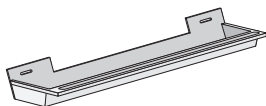

D Easel Legs (2)

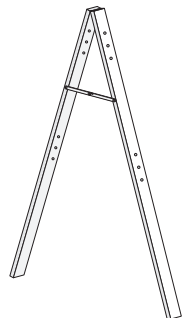

E Hex Screws & Plastic Nuts (8/8)

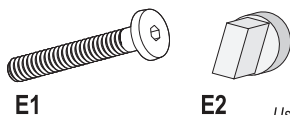

E1

E2

Use the Hex Tool

F Clips (4)



1 Install the Dry Erase Board

Open an **Easel Leg (D)** completely and secure the hinge into the locked position. Place onto a protective surface with the locked hinge facing down.

Install the **Dry Erase Board (B)** onto **Easel Leg (D)** with two **Hex Screws & Plastic Nuts (E1/E2)** as shown.

Reminder: Do not overtighten, as the plastic threads can be stripped.

Note: The height of the board/tray can be adjusted by installing into upper/lower sets of holes on the Easel Legs.

Carefully rotate onto the **Dry Erase Board (B)** on a protective surface.

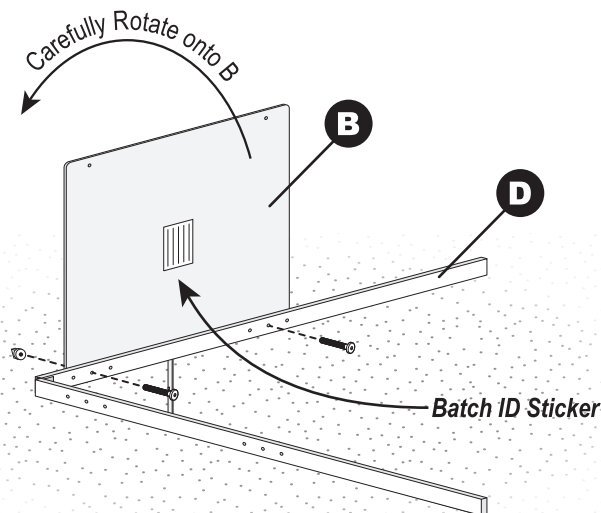

2 Install the Chalk Board and Tray

Open the other **Easel Leg (D)** completely and secure the hinge into the locked position.

Install the **Chalk Board (A)** onto both **Easel Legs (D)** with four **Hex Screws & Plastic Nuts (E1/E2)**. Align a **Tray (C)** behind the **Chalk Board (A)** before tightening the lower hex screws and plastic nuts.

Tip: Install the upper Hex Screws & Plastic Nuts first.

Reminder: Do not overtighten, as the plastic threads can be stripped.

Carefully rotate upright.

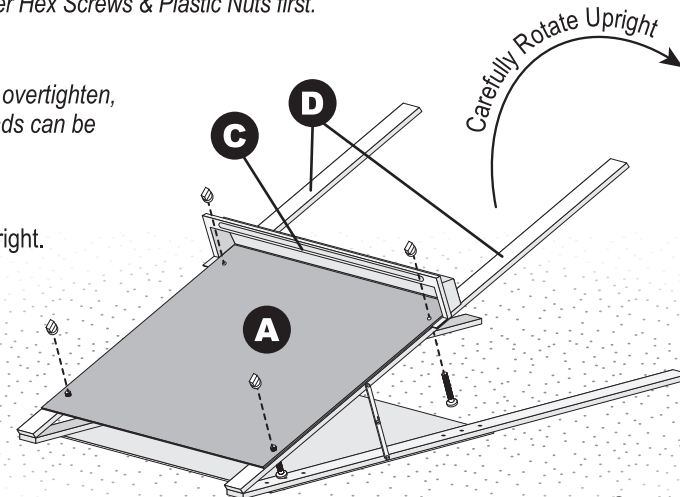

See Next Page

3 Complete Dry Erase Board Installation

Complete the installation of Dry Erase Board (B) onto left Easel Leg (D) with two Hex Screws & Plastic Nuts (E1/E2).

Remove the lower Hex Screws & Plastic Nuts (E1/E2) on the Dry Erase Board (B). Align a Tray (C) behind the Dry Erase Board (B) and re-install the lower Hex screws & Plastic nuts.

Reminder: Do not overtighten, as the plastic threads can be stripped.

Clip paper from the top edge of your Easel with the four Clips (F).

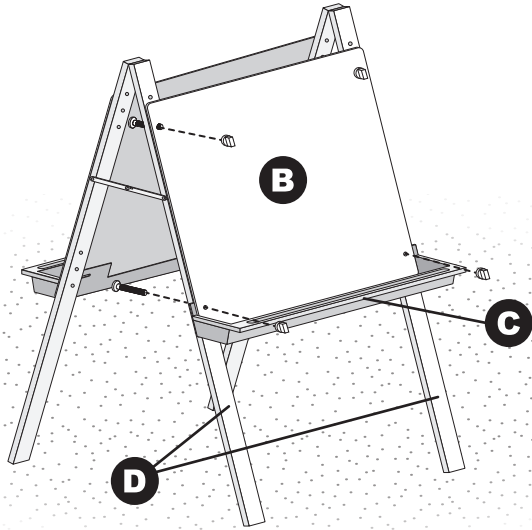

Care and Cleaning

Clean wood with a damp cloth or sponge using warm water and mild soap. Wipe dry.

Do not place near heat, moisture or vaporizer which may cause wood to warp and peel.

Check for loose or worn parts periodically and tighten or replace as necessary.



We appreciate your purchase of the Adjustable Art Easel. ECR4KIDS has made every effort to supply a quality product that with proper use and care, will provide many years of trouble-free use.

If you experience any difficulties with this product, please email us at ecrcs@ecr4kids.com or call toll-free at (855) ECR-4KIDS (Monday - Friday, 7:00am - 4:00pm Pacific Standard Time)

Please do not return to place of purchase as ECR4KIDS will replace defective part(s) and/or product.

Warranty: Visit our website for product specific warranty information at: www.ecr4kids.com

Record the manufacture date here.
Information is located on the Batch ID sticker and on the shipping carton.
Save this sheet in an accessible place.

Model Number: ELR-008-A

Factory Code: DV

Manufacture Date: _____

Batch ID Number: _____
(Located on Part B)