

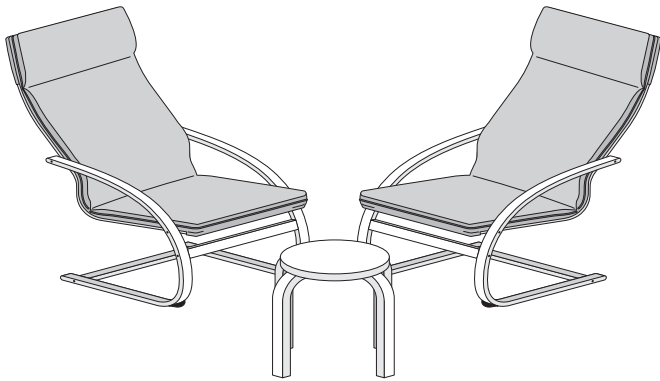

San Diego, CA 92110 USA
www.ecr4kids.com

3pc Comfort Chairs & Table Set Model# ELR-0344-B



⚠ WARNING:

Adult Assembly Required.

Two adults recommended.

- Contains small parts, sharp points and edges.
- **Maximum Chair Weight Limit : 75 lbs.**
Exceeding this weight may cause product to collapse, causing serious injury and/or property damage.
- Do not stand, sit, kneel, climb, lean or pull on unit for support.
- Never leave children unattended.
- Do not place unit near high heat or moisture.
- Adult supervision recommended.

TOOLS INCLUDED

- Hex Tool (1)





TOOLS NEEDED

- Flat-Head Screwdriver

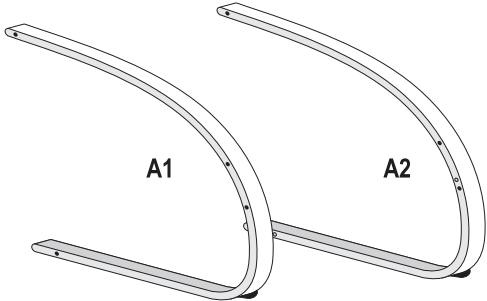
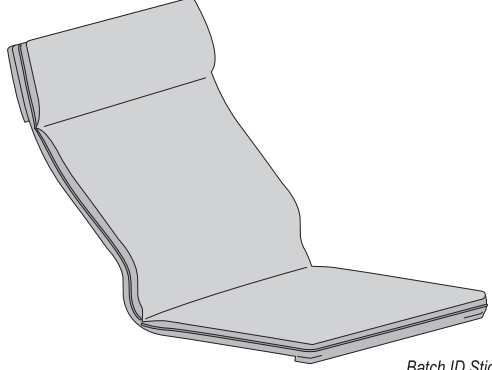
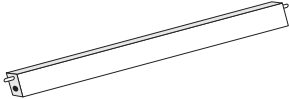
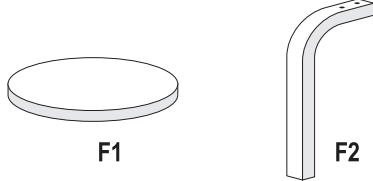
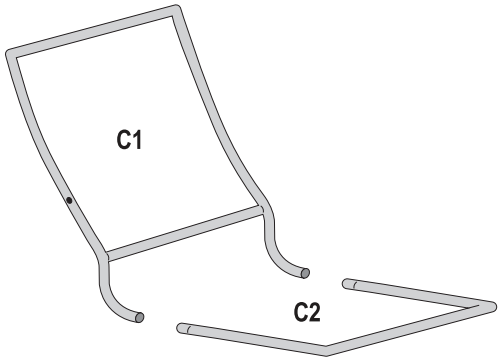
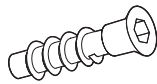
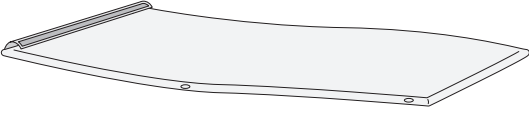
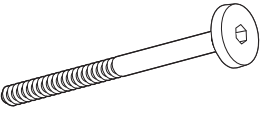
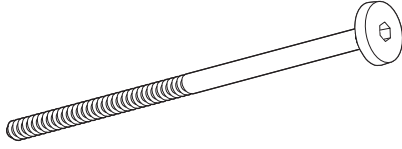

Parts List

BEFORE ASSEMBLING, MAKE SURE YOU HAVE ALL THE PARTS

<p>A Left & Right Side Frames (2/2)</p> 	<p>E Seat Cushion (2)</p>  <p><i>Batch ID Sticker located on Tag</i></p>
<p>B Crossbars (4)</p> 	<p>F Table Top & Legs (1/4)</p> 
<p>C Seat Frame (2/2)</p> 	<p>G Hex Screws (8)</p> 
<p>D Seat Frame Cover (2)</p> 	<p>H Short Decorative Hex Screws (8)</p>  <p><i>Use the Hex Tool</i></p>
	<p>I Long Decorative Hex Screws (8)</p>  <p><i>Use the Hex Tool</i></p>
	<p>J Barrel Nuts (8)</p>  <p><i>Use a Flat-Head Screwdriver to Align</i></p>

1 Install the Crossbars

Insert a **Barrel Nut (J)** into the recessed hole on each end of the **Crossbars (B)**, rotate the Barrel Nuts with a Flat-Blade screwdriver so the threaded hole aligns with screw hole on the end of the Crossbar.

Insert the pre-installed wooden dowels on **Crossbars (B)** into the corresponding holes on the inside of the **Left Side Frame (A1)**.

Install the **Crossbars (B)** onto the **Left Side Frame (A1)** with two **Long Decorative Hex Screws (I)** using the Hex Tool, so they thread into the **Barrel Nuts (J)**.

*Tip: Install the **Crossbars (B)** with the recessed holes for the Barrel Nuts facing toward the floor/back of chair for a more aesthetic look (as shown).*

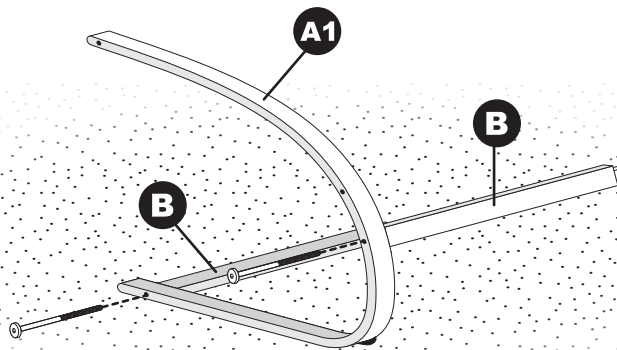

2 Install the Right Side Frame

Insert the pre-installed wooden dowels on **Crossbars (B)** into the corresponding holes on the inside of the **Right Side Frame (A2)**.

Install the **Crossbars (B)** onto the **Right Side Frame (A2)** with two **Long Decorative Hex Screws (I)** using the Hex Tool, so they thread into the **Barrel Nuts (J)**.

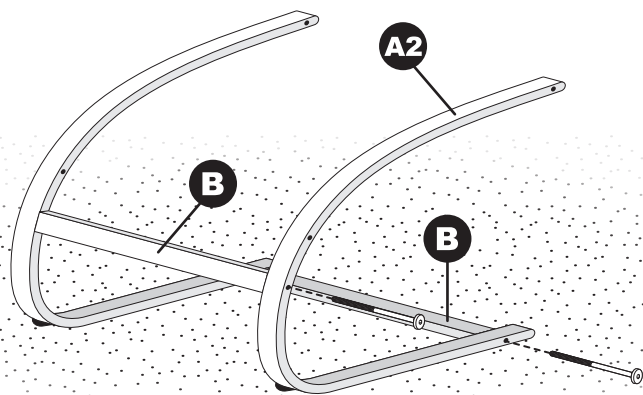

3 Connect the Seat Frame Together

Insert the **Upper Seat Frame (C1)** onto the **Lower Seat Frame (C2)**, so they are seated firmly together.

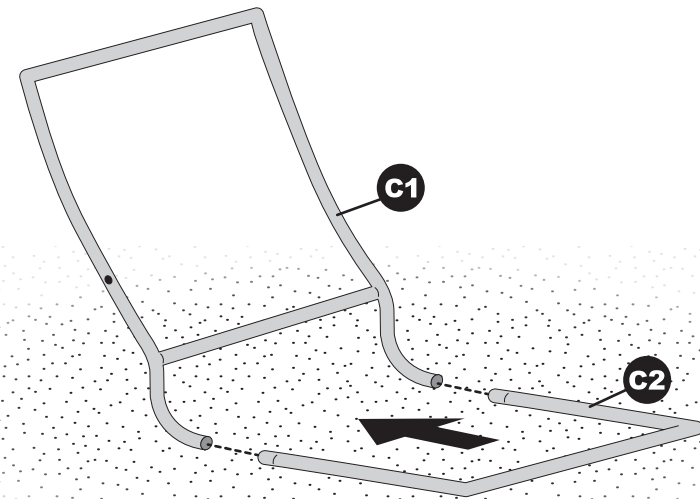

4 Slide the Seat Frame Cover on

Slide the **Seat Frame Cover (D)** onto the **Seat Frame (C)** starting at the bottom of the Seat Frame. Secure the Hook & Loop connection at the top of the seat frame.

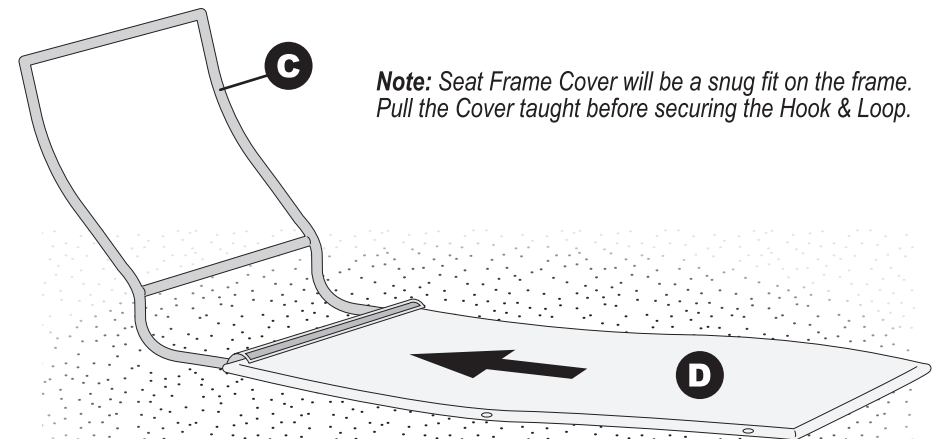

See Next Page

5 Install the Seat Frame

Install the **Seat Frame (C)** onto the **Left/Right Side Frames (A1/A2)** with four **Short Decorative Hex Screws (H)** using the Hex Tool.

Tip: Loosely install the front two Hex Screws first, with the back of the Seat Frame laying on the ground.

Rotate the top of the Seat Frame upward, and install the rear Hex Screws. Tighten all screws firmly.

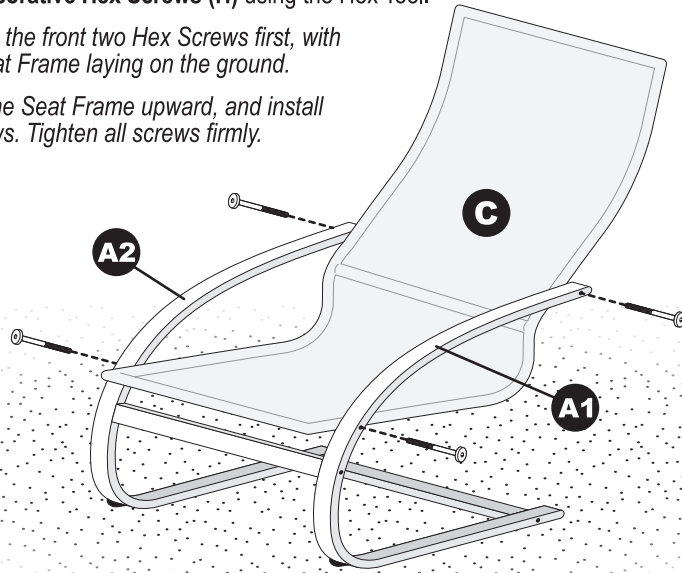

6 Install the Seat Cover

Install the **Seat Cover (E)** onto the **Seat Frame (C)**, starting with the deep pocket on the Seat Cover, insert the pocket over the top of the Seat Frame. Repeat with the bottom pocket onto the bottom of the Seat Frame.

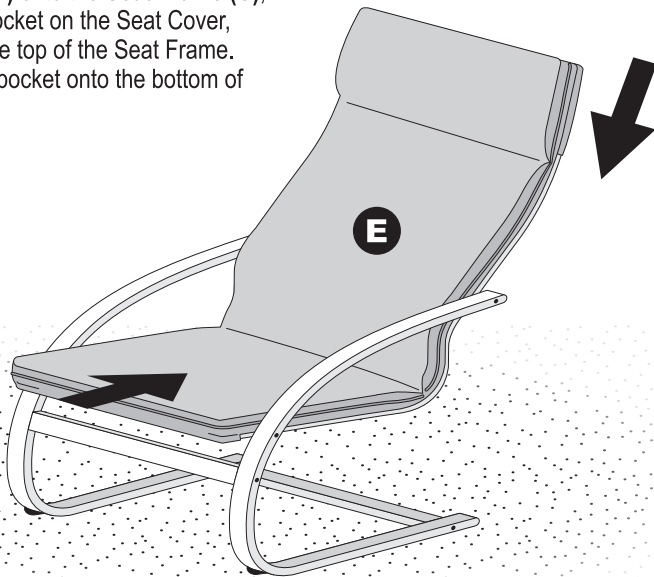

7 Install Table Legs

Install the **Table Legs (F2)** onto the **Table Top (F1)** with eight **Hex Screws (G)** using the Hex Tool.

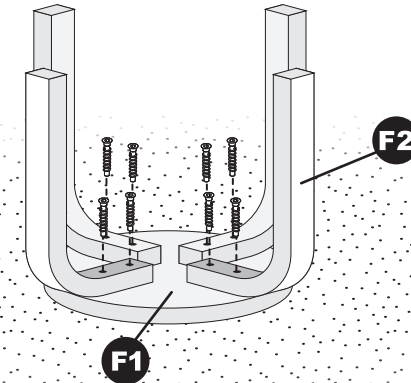

⚠ WARNING:

- Maximum Chair Weight Limit : 75 lbs.

Exceeding this weight may cause product to collapse, causing serious injury and/or property damage.

- Do not stand or sit on table.



We appreciate your purchase of the 3pc Comfort Chairs & Table Set. ECR4KIDS has made every effort to supply a quality product that with proper use and care, will provide many years of trouble-free use.

If you experience any difficulties with this product, please email us at ecrcs@ecr4kids.com or call toll-free at (855) ECR-4KIDS (Monday - Friday, 7:00am - 4:00pm Pacific Standard Time)

Please do not return to place of purchase as ECR4KIDS will replace defective part(s) and/or product.

Warranty: Visit our website for product specific warranty information at: www.ecr4kids.com

Care and Cleaning

Clean wood with a damp cloth or sponge using warm water and mild soap. Wipe dry.

Hand or machine wash fabrics separately in cold water using gentle cycle. Do Not Bleach. Tumble dry low or air dry flat.

Do not place near heat, moisture or vaporizer which may cause wood to warp and peel.

Check for loose or worn parts periodically and tighten or replace as necessary.

Record the manufacture date here. Information is located on the Batch ID sticker and on the shipping carton. Save this sheet in an accessible place.

Model Number: ELR-0344-B

Factory Code: EM

Manufacture Date: _____

Batch ID Number: _____
(Located on Part E)