

Colorful Essentials Double-Sided Toddler Book Storage Island Model# ELR-0718

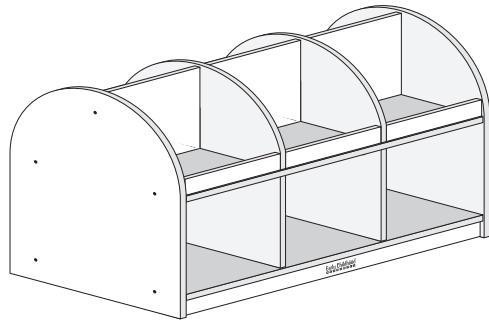

⚠ WARNING:

Adult Assembly Required.

- Two adults recommended.
- Contains small parts, sharp points and edges.
- Do not stand, sit, kneel, climb, lean or pull on unit for support.
- Never leave children unattended.
- Do not place unit near high heat or moisture.
- Adult supervision recommended.

TOOLS INCLUDED

- Hex Tool (1)



TOOLS NEEDED

- Phillips Screwdriver



Parts List

BEFORE ASSEMBLING, MAKE SURE YOU HAVE ALL THE PARTS

A

Side Panels (2)

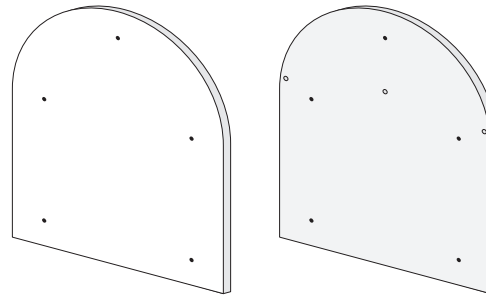

F

Center Divider (1)

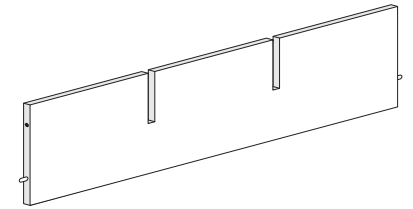

B

Upper Shelf (1)

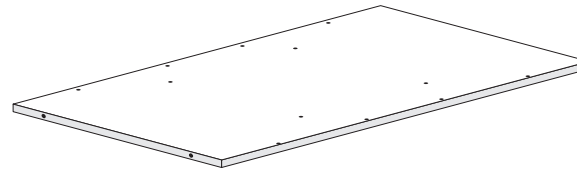

G

Lower Dividers (2)

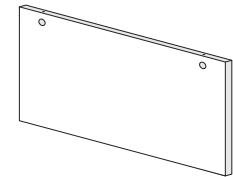

C

Bottom Shelf (1)

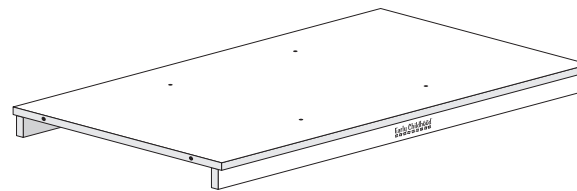

H

Decorative Hex Screws (22)

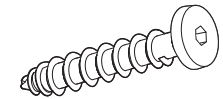

Use the
Hex Tool.

I

Flat Head Hex Screws (4)

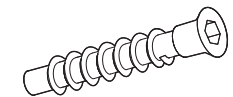

Use the
Hex Tool.

D

Upper Dividers (2)

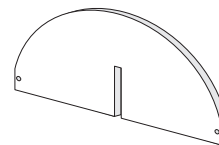

J

Cam Posts & Cam Locks (4/4)

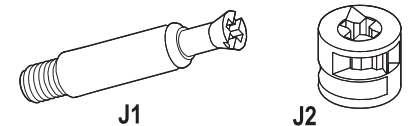

J1

J2

Use a Phillips
Screwdriver.

E

Inner & Outer Front Panels (2/4)



E1



E2

1 Insert Center Divider onto Upper Dividers

Align the slits on **Center Divider (F)** with the slit on each **Upper Divider (D)** and slide together.

*Note: The holes on the face of the **Upper Dividers (D)** face outward as shown.*

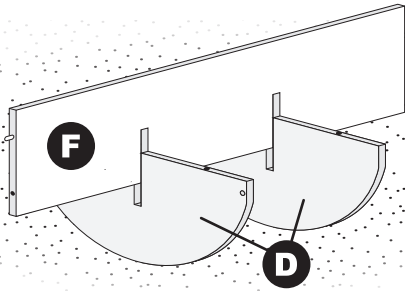

2 Install Upper Shelf to Upper Dividers

Install the **Upper Shelf (B)** onto the **Upper Dividers (D)** with four **Flat Head Hex Screws (I)** using the Hex Tool.

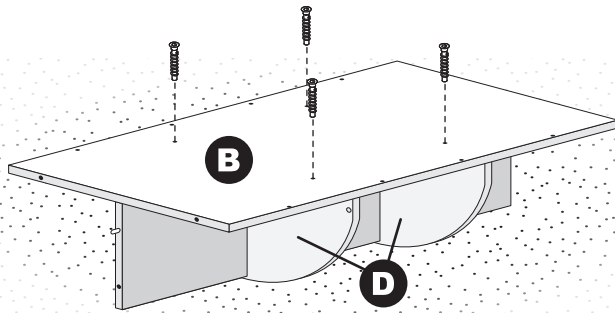

3 Install the Inner Front Panels

Install the **Inner Front Panels (E1)** onto the **Upper Shelf (B)** with four **Decorative Hex Screws (H)** using the Hex Tool.

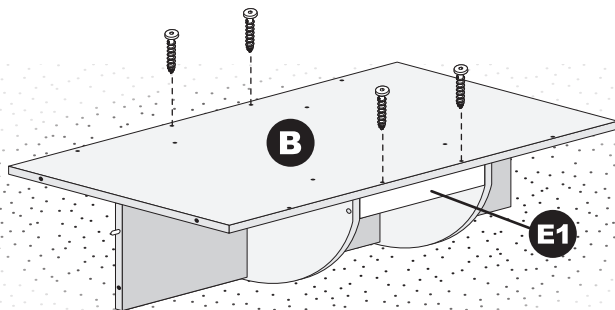

4 Install the Outer Front Panels

Insert the pre-installed wooden dowels on the **Outer Front Panels (E2)** into the corresponding holes on the outside of the **Upper Dividers (D)** and install them onto the **Upper Shelf (B)** with four **Decorative Hex Screws (H)** using the Hex Tool.

Install four **Cam Posts (J1)** into the threaded plastic inserts on the underside of **Upper Shelf (B)** with a Phillips screwdriver.

Reminder: Do not overtighten, as the plastic threads can be stripped.

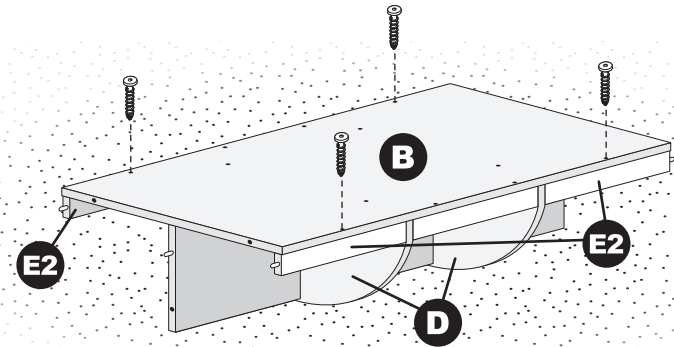

5 Install the Lower Dividers

Place two **Cam Locks (J2)** into the recessed holes on each **Lower Divider (G)**, with the arrow facing the closest edge.

Attach the **Lower Dividers (G)** onto the **Cam Posts** on the underside of the **Upper Shelf (B)**, turn the **Cam Locks** clockwise with a Phillips screwdriver to lock the **Lower Dividers (G)** onto the posts.

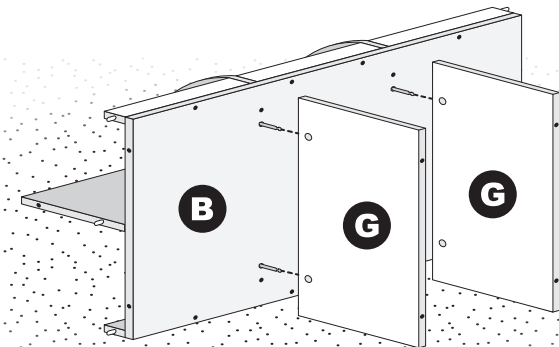

See Next Page

6 Install the Bottom Shelf

Install the **Bottom Shelf (C)** onto the **Lower Dividers (G)** with four **Decorative Hex Screws (H)** using the Hex Tool.

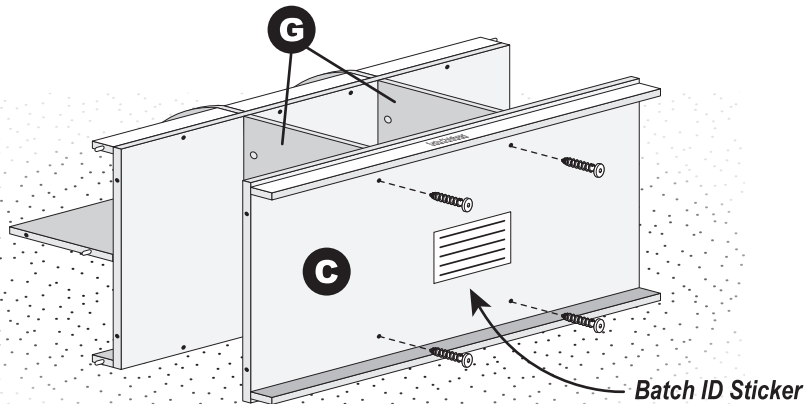

7 Install the Side Panels

Install the **Side Panels (A)** onto the **Upper/Lower Shelves (B/C)** with ten **Decorative Hex Screws (H)** using the Hex Tool.

Two Adults Recommended:
Carefully rotate the unit upright.

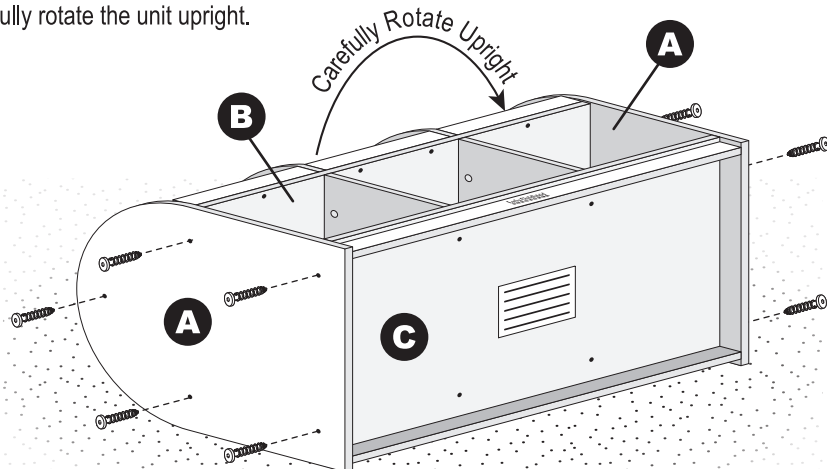

Early Childhood[®]
RESOURCES

We appreciate your purchase of the CE Double-Sided Toddler Book Storage Island. Early Childhood Resources has made every effort to supply a quality product, that with proper use and care, will bring you many years of trouble free use!

If you experience any difficulties with this product, please email us at customerservice@ecr4kids.com or call toll-free at (888) 227-9028 (Monday - Friday, 7:00am - 4:00pm Pacific Standard Time)

Please do not return to place of purchase as Early Childhood Resources will replace defective part(s) and/or product.



"Early Childhood Resources® guarantees the quality of all of our products. You can trust the quality and safety of our furniture and materials, along with the peace of mind that our products are made to last. If for any reason, you are not satisfied with the quality and workmanship of our products, we will replace the item or refund the sale."

Care and Cleaning

Clean unit with a damp cloth or sponge using warm water and mild soap. Wipe dry.

Do not place near heat, moisture or vaporizer which may cause panels to warp and peel.

Check for loose or worn parts periodically and tighten or replace as necessary.

Record the manufacture date here. Information is located on the Batch ID sticker and on the shipping carton. Save this sheet in an accessible place.

Model Number: ELR-0718

Factory Code: D

Manufacture Date: _____

Batch ID Number: _____
(Located on Part C)