

# Hardwood Unit Blocks

## ELR-078 Reference Chart

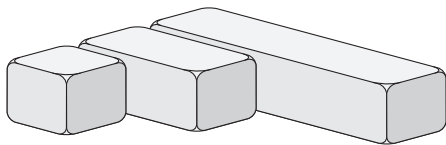

**UB-01** Quarter Pillar  
**UB-02** Half Pillar  
**UB-03** Pillar

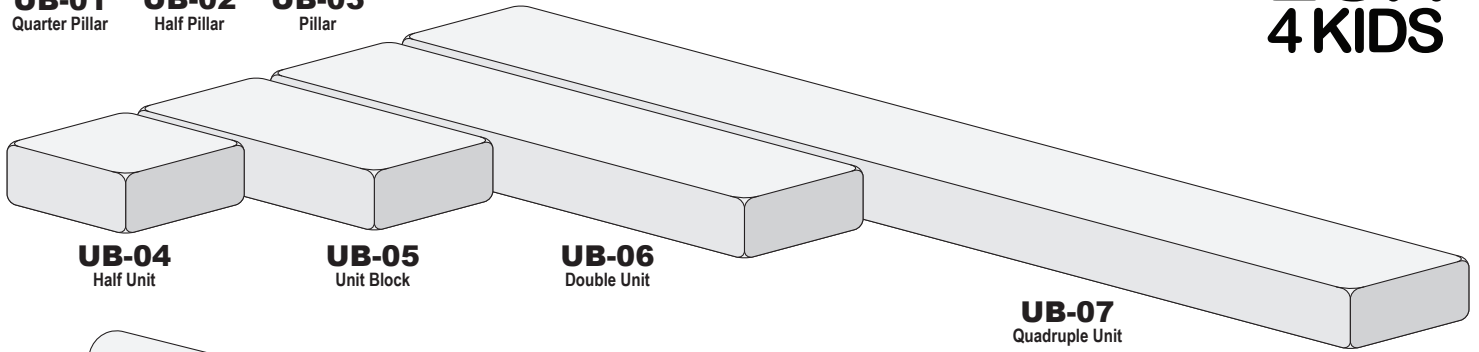

**UB-04** Half Unit  
**UB-05** Unit Block  
**UB-06** Double Unit  
**UB-07** Quadruple Unit



**UB-10** Column

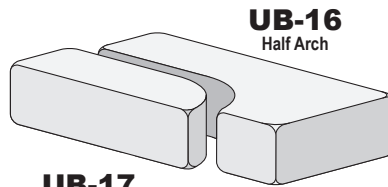

**UB-16** Half Arch  
**UB-17** Small Buttress

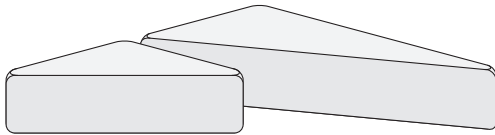

**UB-12** Diagonal  
**UB-13** Triangle

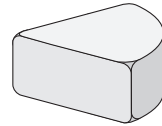

**UB-26** Quarter Circle

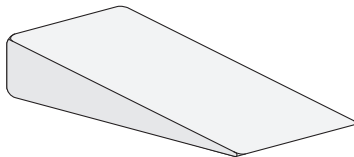

**UB-15** Ramp

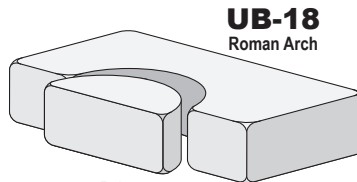

**UB-18** Roman Arch  
**UB-19** Small Half Circle

ELR #	Description	ELR-078
UB-01	Quarter Pillar	4
UB-02	Half Pillar	4
UB-03	Pillar	4
UB-04	Half Unit	9
UB-05	Unit Block	20
UB-06	Double Unit	6
UB-07	Quadruple Unit	2
UB-10	Column	6
UB-12	Diagonal	4
UB-13	Triangle	6
UB-15	Ramp	4
UB-16	Half Arch	1
UB-17	Small Buttress	1
UB-18	Roman Arch	1
UB-19	Small Half Circle	1
UB-26	Quarter Circle	2
<b>Totals</b>		<b>75</b>