

CONTENIDO • CONTENTS • CONTENU • CONTEÚDO

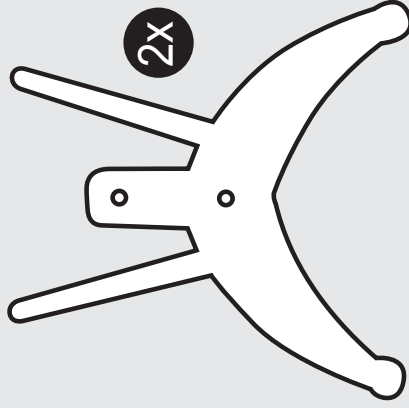

FEBER es una marca registrada de FEBER S.A. en Alemania. FEBER es una marca registrada de FEBER S.A. en México.

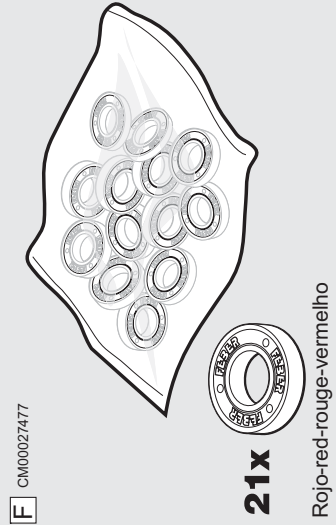
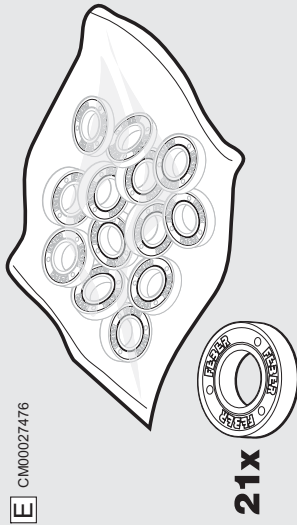
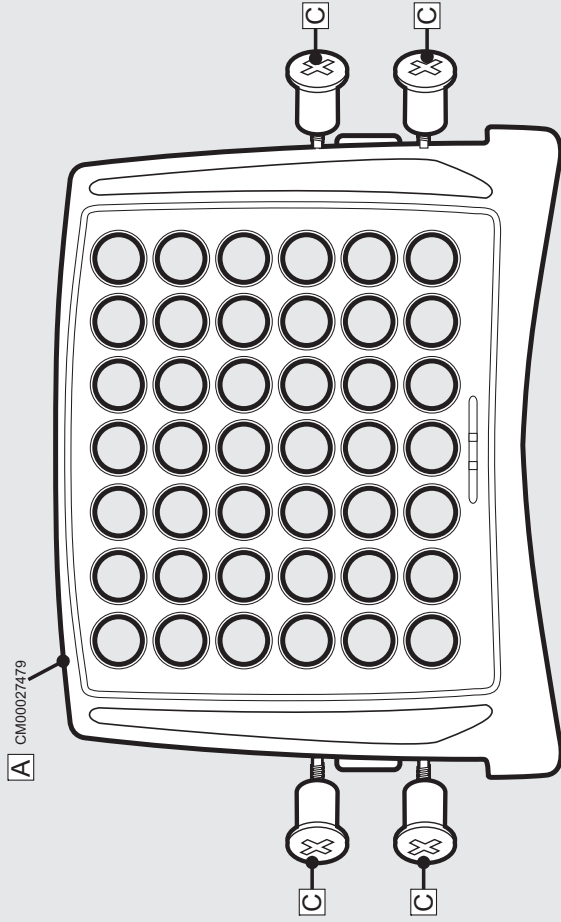

JUGUETES FAMOSA, S.A. de C.V.
 Av. Patón No. 122
 Parque Industrial Kalos
 66600 Apodaca, N.L., México
 R.F.C. IEU030805U0

SUPER 4 IN LINE

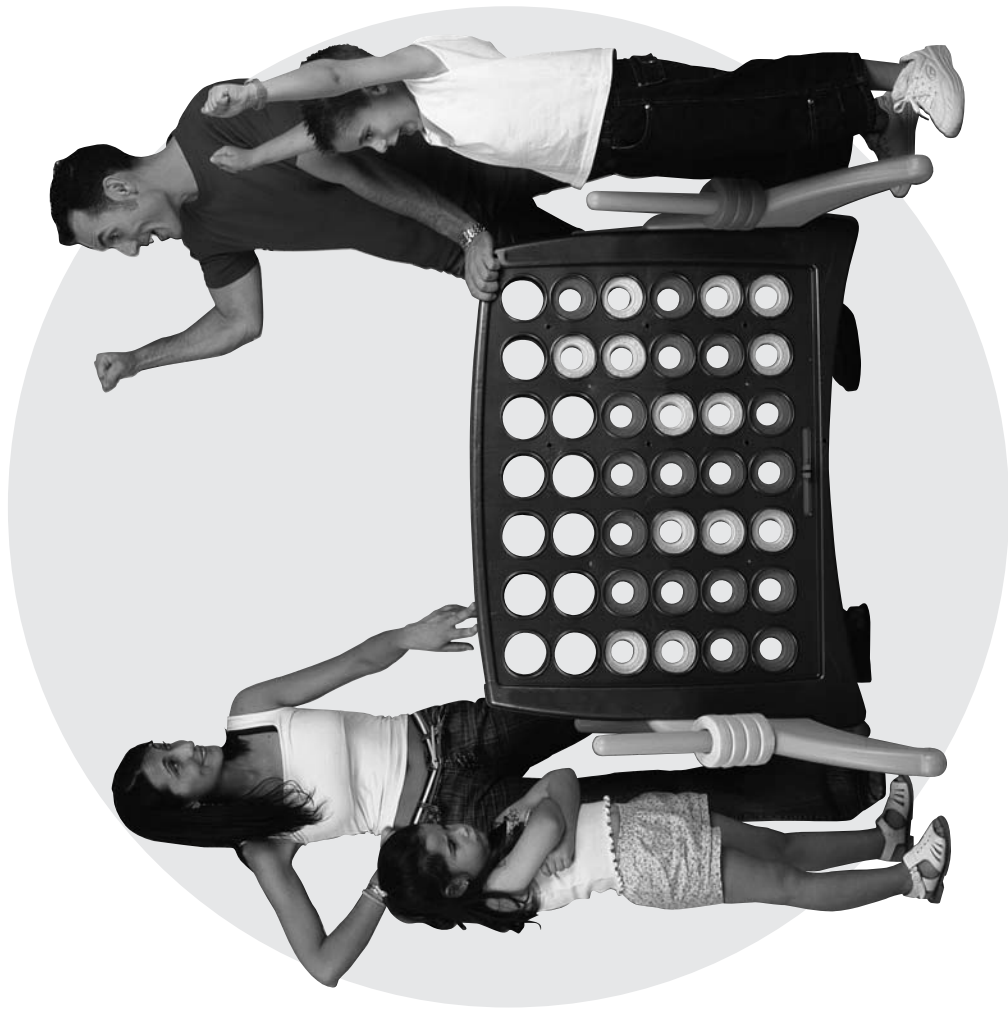

MONTAJE • ASSEMBLY • ASSEMBLAGE • MONTAGEM

- Realizar por un adulto
- This should be done by an adult

- A réaliser par un adulte
- A realizar por um adulto

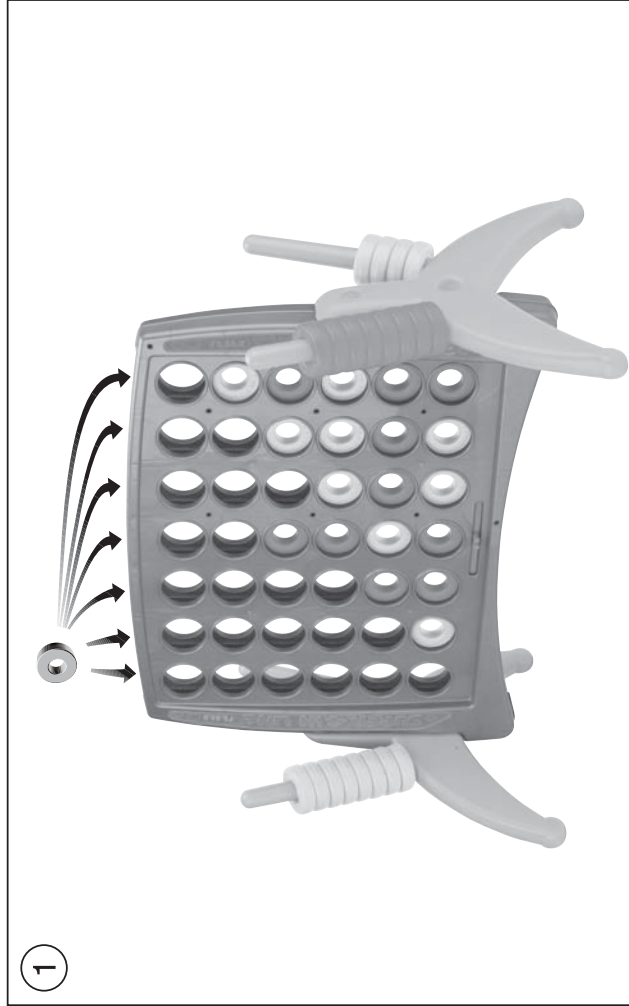
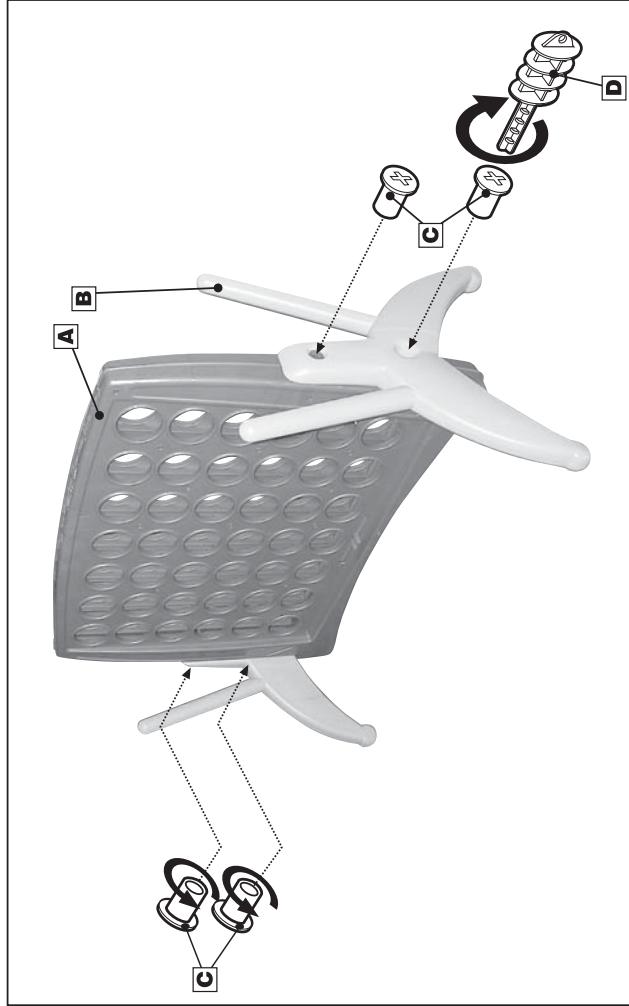

1

2

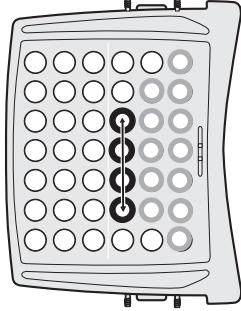
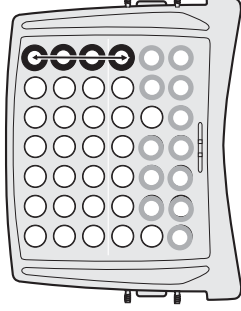
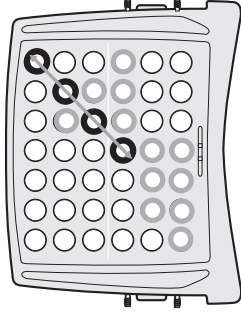

3

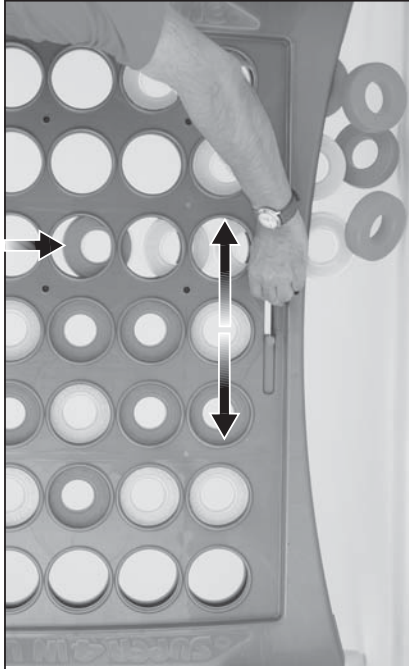

4

